

ESL Series

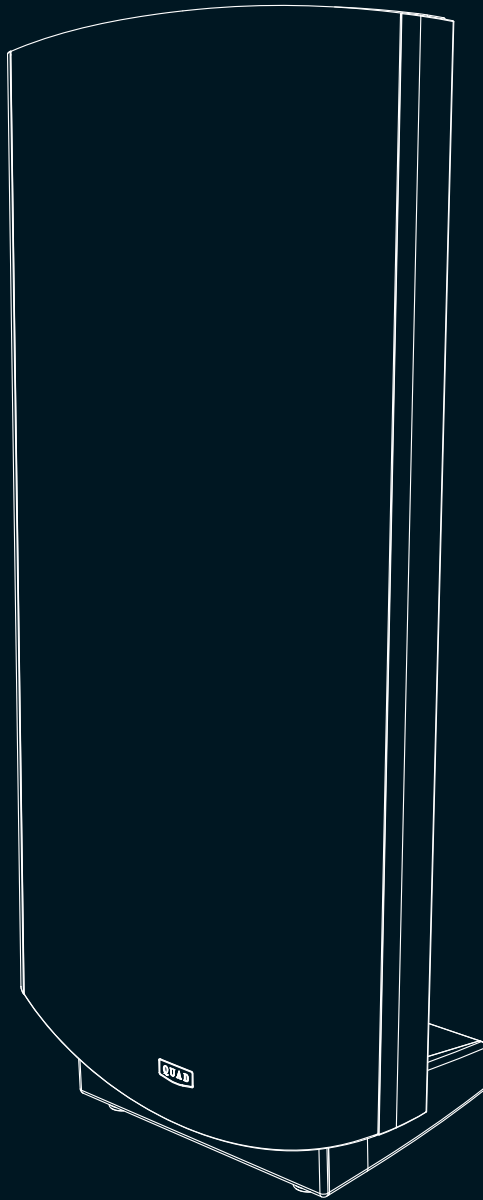

ESL 2812
ESL 2912

Owner's Manual

QUAD

the closest approach to the original sound

Important Safety Instructions

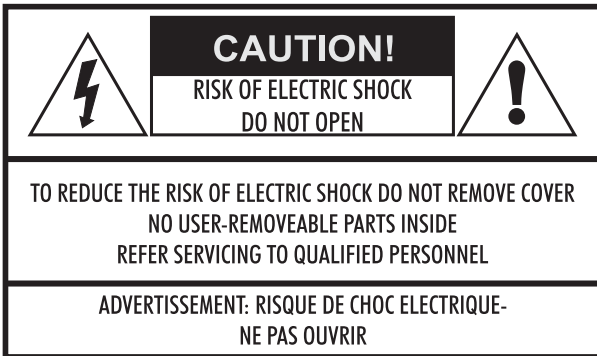

This symbol indicates that dangerous voltage constituting a risk of electric shock is present within this unit.



This symbol indicates that there are important operating and maintenance instructions in the literature accompanying this unit.

Read these instructions.

Keep these instructions.

Heed all warnings.

Follow all instructions.

Do not use this apparatus near water.

Clean only with dry cloth.

Do not block any ventilation openings.

Install in accordance with the manufacturer's instructions.

Do not install near any heat sources such as radiators, heat registers, stoves, or other apparatus (including amplifiers) that produce heat.

Do not defeat the safety purpose of the polarised or grounding plug. A polarised plug has two blades with one wider than the other. A grounding plug has two blades and a third grounding prong. The wide blade or the third prong is provided for your safety. If the provided plug does not fit into your outlet, consult an electrician for replacement of the obsolete outlet.

Protect the power cord from being walked on or pinched particularly at plugs, convenience receptacles, and the point where they exit from the apparatus.

Only use attachments/accessories specified by the manufacturer.



Use only with the cart, stand, tripod, bracket, or table specified by the manufacturer, or sold with the apparatus. When a cart or rack is used, use caution when moving the cart/apparatus combination to avoid injury from tip-over.

Unplug this apparatus during lightning storms or when unused for long periods of time.

Refer all servicing to qualified personnel. Servicing is required when the apparatus has been damaged in any way, such as where the power supply cord or plug is damaged, liquid has been spilt or the apparatus exposed to rain or moisture, does not operate normally, or has been dropped.

CAUTION: These servicing instructions are for use by qualified service personnel only. To reduce the risk of electric shock, do not perform any servicing other than that contained in the operating instructions unless you are qualified to do so.

WARNING: To reduce the risk of fire or electric shock, do not expose this apparatus to rain or moisture. The apparatus shall not be exposed to dripping or splashing liquid and objects filled with liquids, such as vases, shall not be placed on the apparatus.

No naked flame sources, such as lighted candles, should be placed on the apparatus.

CAUTION: Changes or modifications not expressly approved by the manufacturer could void the user's authority to operate this device.

WARNING: The mains plug/appliance coupler is used to disconnect the device and must remain readily operable.

CAUTION: Do not power the speaker for at least 8 hours after unpacking until temperature and humidity levels stabilise.



This equipment is a Class II or double insulated electrical appliance. It has been designed in such a way that it does not require a safety connection to electrical earth.



IAG-QUAD

Correct disposal of this product. This marking indicates that this product should not be disposed with other household wastes throughout the EU. To prevent possible harm to the environment or human health from uncontrolled waste disposal, recycle it responsibly to promote the sustainable reuse of material resources. To return your used device, please use the return and collection systems or contact the retailer where the product was purchased. They can take this product for environmentally safe recycling.

Contents

Introduction	1
The ESL Choice	1
What's in the Box?	2
Unpacking and Assembly	3
Positioning the Loudspeakers	4
Choosing and Preparing Loudspeaker Cable	5
Connecting Your Loudspeakers	5
Operations	6
Final Adjustments	7
Horizontal Directivity	8
Maintenance and Service	10
Quality Assurance	11
About Your ESL Loudspeaker	12
Specifications	13
Physical Measurement.....	14
The Closest Approach.....	15

Introduction

Congratulations, you are now the owner of a pair of the world's finest loudspeakers.

For 55 years Quad Electroacoustics has produced the world's most advanced Electrostatic loudspeakers, considered by many to be the most accurate and neutral of all speakers.

The ESL 2812 and 2912 represent the latest evolution of the unique Quad electrostatic concept. Radically redesigned using the most up to date materials and processes, these new evocations of our design philosophy achieve levels of detail, clarity and perspective that will be a revelation and source of continuing delight to all music lovers.

The ESL 2812 and 2912 are doublets or dipole speakers, incorporating special panels that produce a spherical sound field from a point source. All naturally created sounds emanate from a point source and the ESL speaker concept recreates this effect more than any other speaker currently available. Another key feature of the ESL push-pull design is very low distortion - your Quad ESLs are probably the lowest distortion loudspeakers ever made - and this includes the bass region where conventional speakers suffer from time related delays and harmonically related distortions.

The result is a loudspeaker of unsurpassed accuracy and one which has stood the test of time. Major recording studios have ESLs amongst their reference monitoring loudspeakers and our loudspeakers are consistently in demand by audiophiles who value the clear, natural sound that is uniquely the hallmark of all QUAD products.



The ESL Choice

Ask many of the most respected music industry professionals in the world what their speaker of choice is – the answer is surprisingly common. The Quad ESL opens a window on a recording unlike any other speaker.

More hi-fi critics regard the Quad ESL as an absolute reference for their listening than any other loudspeaker. They are regularly praised by leading magazines, winning Golden Ears from the Absolute Sound (USA); and not just 'Product of the Year', but also 'Component of the Year' from Stereophile (USA); a Diapason D'Or award (France); a 'System of the Year' award from Hi-Fi News Magazine; and a 'Best Product' from EISA Award.

For those involved in the recording industry, their reputation is unsurpassed. The transparency of their reproduction has won them many fans. For professional musicians and studios, this is an invaluable asset. It allows them to hear exactly what has been recorded in perfect balance.

Because of their speed and neutrality, they are unaffected by the overhang and box-like character of the moving-coil alternative.

The Quad ESLs have been used by recording engineer Tony Faulkner for many years. He first started using the ESL-63 and the ESL-63 pro for his critical monitoring.

Tony has produced over a thousand classical music recordings using the Quad ESL because he knows he can trust what he hears – that the very essence of the performance is being transferred.

When using the Quad ESLs for listening at home you can be sure that your experience will mirror that of the concert hall. You will hear details and depth in the recording revealed for the very first time and each listening session will draw you further into the music, transforming your appreciation of each great performance and every great recording.

What's in the Box?

The packing contains the following items:

- The Quad ESL loudspeaker
- AC power lead 3m with a mains connector suitable for your area
- This Owner's Manual
- Warranty Registration Form
- A set of four spiked feet
- A set of four standard feet
- Four clamping collars
- One collar locking bar
- Base stabiliser weight
- Two securing brackets, screws and shakeproof washers
- Two pairs of cotton gloves

Consult the dealer from whom you purchased the equipment if any of these items is not present.

Please retain the packing materials for future use or return them to your dealer. If you decide not to keep the packing, please dispose of it sensibly. The timber, paper and plastics components are recoverable and may be taken to an appropriate recovery service.

Please retain the owner's manual and the information concerning the date and place of purchase of this equipment for future reference. In the unlikely event that you pass this product on to a third party, please include all the accessories and this owner's manual.



Unpacking and Assembly

These loudspeakers are heavy! It needs two people to lift and manoeuvre the loudspeakers into position.

Caution: DO NOT USE THE TENSIONING BRACE TO LIFT OR MANOEUVRE THE ESL OR YOU WILL DAMAGE THE LOUDSPEAKER! WHEN MOVING THE LOUDSPEAKER HOLD IT BY THE SIDES OR THE SIDES AND BASE.

Always use the supplied cotton gloves when handling exposed surfaces.

Before you unpack the loudspeakers, ensure that you have a large and completely clear area of floor on which to work. Remove or protect any fragile carpets, etc. to avoid any damage.

Each ESL loudspeaker is packed in a cardboard outer carton and then packed on a pallet for safe transportation. The carton has a lidded top and a tabbed seam down one long edge which is taped over.

Place the speaker upright, standing on its wooden pallet. Open the top first, and then open the tabbed seam all the way down. Remove the top packing insert, and then remove the box containing the accessories. Remove the side packing pieces. The loudspeaker may now be lifted out of the base packing.

The stabiliser block is strapped to one of the side packing pieces. Cut the ties and remove the block.

Caution: The block is heavy - exercise care.

The ESLs are provided with both spiked and standard feet which screw into the threaded holes in the baseplate. The heights of individual feet can be adjusted to ensure that the loudspeaker sits secure and level on the floor. Determine whether you will be using the spiked or the standard feet. Remember that spiked feet are only suitable for use with carpets as they will damage wood and stone floors. When using spikes take care to avoid the tips which are quite sharp.



Gently lay the loudspeaker down on its front. If the floor surface is hard place a soft cloth such as a towel under the speaker first. Spin one collar onto each foot all the way down but do not tighten.

Attaching the front feet: Insert the two front feet in the threaded inserts on the base and thread them fully in but only hand-tighten them at this stage. Refer to Illustration A below.

Attaching the stabiliser and rear feet: It is essential that you attach the stabiliser as this is both a safety and operational feature. (As an alternative the speaker may be attached to the floor - see Page 7)

First, attach the two clamps to the block using the provided screws and shakeproof washers. Line up the assembly with the mounting holes in the base. Insert the feet through the support brackets and thread them into the base. Ensure that the feet protrude below the clamps by an equal distance. When the speaker is operational the weight/clamp assembly should be clear of the floor surface. Tighten both rear feet. Insert the collar locking bar into a hole in the clamping ring and tighten. Progressively move the bar from hole to hole until the feet are fully locked in place. Refer to Illustration B below.

B Attaching the stabiliser and rear feet.

A Insert bar and tighten clamping ring clockwise.



Positioning the Loudspeakers

However good the loudspeaker, the final results will depend on the acoustic characteristics of the listening room and the position of the loudspeakers in it. Do not be afraid to experiment with both position and orientation and make a point of trying some of the less obvious as well as the more obvious positions. The benefits obtained from the time spent doing this can be very rewarding. The subject of room acoustics is complex and beyond the scope of this manual. It is assumed that the loudspeakers will be used in a room with moderate reverberation, neither too bright nor over damped. Furnishings can alter the acoustic characteristics of the listening room, and here common sense is the best guide.

The loudspeakers have constant directivity over a wide angle in both horizontal and vertical planes, so the response does not vary with the height of the listener's ears from the floor.

When experimenting, it is preferable to use good recordings or works with which you are familiar in the concert hall or good quality speech.

The ESL loudspeaker, being a dipole source, has considerable advantages over conventional loudspeakers in terms of room placement. No energy is radiated in the plane of the diaphragm and, as a consequence, the respective axial room modes are discriminated against. Normally the loudspeaker is placed at an angle to both horizontal room axes. This will excite both sets of horizontal axial modes although this excitation will be 3 dB less than with a conventional source and discriminate entirely against the vertical axial modes.

The loudspeakers should be placed at least 60cm (2 ft) from the rear wall of the listening room and angled towards the listener. Placing the ESLs too close to rear walls will adversely affect their dispersion characteristics; about 1/3 of the way down the length of the room is a good starting point. It is not advisable to operate the loudspeakers across corners, in alcoves or behind furniture. Because ESLs are a homogeneous sound source it will be found that they can be placed considerably further apart than normal, broadening the stereo sound stage. Close proximity to the side walls is not detrimental to performance and can actually benefit the bass response. Simple geometry will show that if the ESL is placed at an angle to the side wall, there will be no audible reflection at the listening position.



Choosing and Preparing Loudspeaker Cable

Specialist audio cable will usually offer better performance than general purpose 'bell' or 'zip' wire. Audio cable is polarised, with two cores of different colours, or often, in the case of twin cable, a coloured tracer or ridge along one wire to indicate polarity. Choose a cable of suitable diameter - cable that is too thin will limit the dynamics of the sound and may impair the bass response. Split the twin cores to a depth of about 25mm. Carefully strip the insulation from each end, leaving about 7mm of bare wire. If the cable is stranded, lightly twist together any loose strands.

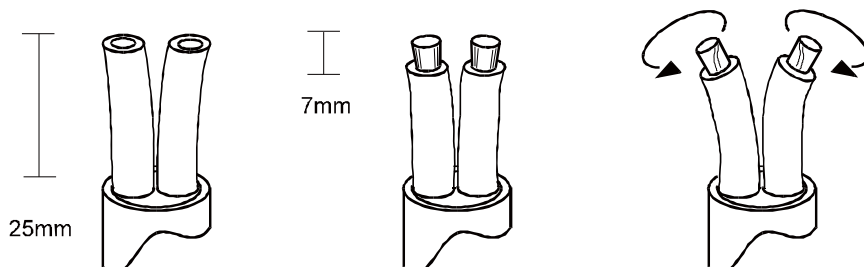

Connecting Your Loudspeakers

Lift the cover off the connections panel box and store it safely until you have finished connecting the speakers. The cover is magnetic for easy removal and replacement.

Choose an equal length of twin core speaker cable for each channel, and prepare the ends as described above. Unscrew each speaker terminal. Thread the bared end of each cable through the hole in the bottom of the terminal post. Ensure that there are no loose strands which may touch adjacent terminals. Retighten the terminal securely.

Connect the positive(+) terminal of the Left loudspeaker to the corresponding positive(+) amplifier terminal. Connect the negative(-) terminals similarly. Repeat this procedure for the Right Channel. Note that the positive(+) terminals are located on the right.

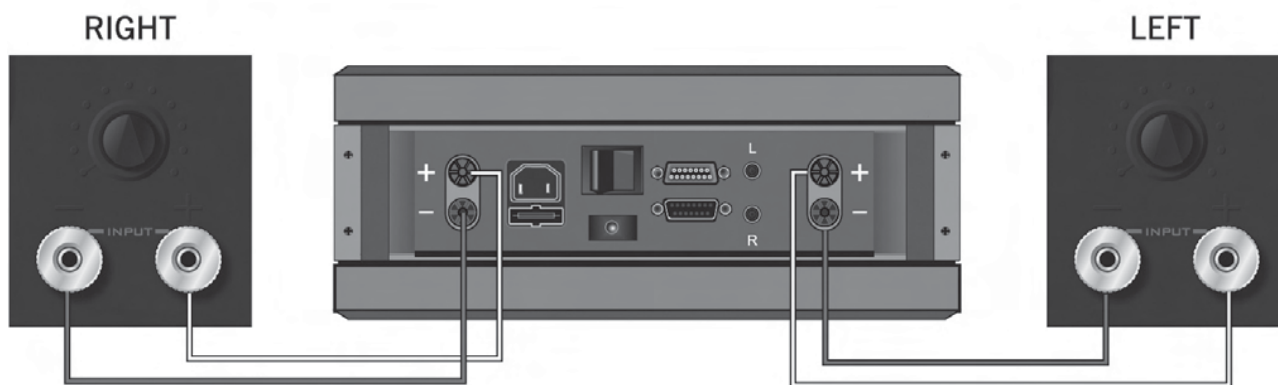

Phase

If there is any doubt about the way the loudspeakers are connected, their phasing can easily be checked by playing a mono source – the sound should appear to emanate from a point midway between the two loudspeakers. If this is hazy and poorly defined, then the connections to one of the loudspeakers should be reversed. When correctly connected, the loudspeakers will give a precise and defined centre sound source with more full bodied tenor and bass registers.

Operations

The ESL loudspeaker requires an energising voltage for operation and needs to be connected to an AC power supply. Before connecting to the AC power supply check that the voltage range marked on the base corresponds with that of the supply.

The on/off switch has a rocker action; press the bottom to switch the ESL on and the top to switch it off. An LED next to the on/off switch indicates that the speaker is on. As supplied, the Quad logo on the speaker bezel is switched off. To switch it on turn the Logo Dimmer control clockwise so that it clicks. The intensity of the illumination may also be altered via this control.

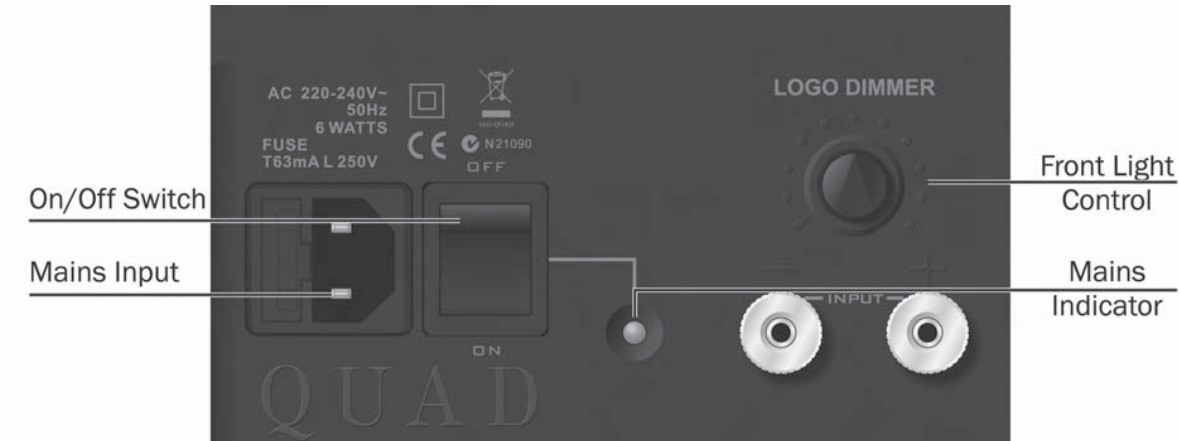

Amplifier Requirements

The ESL loudspeaker should be used with an amplifier of output capability of 20V - 30V rms (40-100W into 8 Ohms). The impedance characteristic presents no problems to an amplifier that is unconditionally stable. Protection circuits limit the maximum input voltage to 40V and there is no benefit from using an amplifier with an output greater than 30V rms (100W into 8 Ohms). Amplifiers with an output capability in excess of 35V rms (150W into 8 Ohms approx) may be used but with caution – see Loudspeaker Protection.

If the Quad 405/2 power amplifier is used, the amplifier voltage limiters should not be fitted.

Loudspeaker Protection

 The ESL loudspeaker is fitted with a protection circuit, incorporating a special device called a multifuse, which prevents damage from excessive programme input signals. Should the loudspeaker be severely overdriven for any length of time, the circuit will operate and effectively reduce the drive to the loudspeaker, causing a reduction in the volume level with some loss of quality. If this occurs, then the volume control of the amplifier should be turned down. After a delay of a few seconds to allow the circuit to reset, the volume can be increased, but only to a point below which the protection circuit initially functioned, otherwise the circuit may operate again.

Persistently overdriving the loudspeaker will cause the multifuse to completely fail, necessitating its replacement by a qualified engineer. The above conditions are unlikely to occur in normal use or with amplifiers with a power output rating of less than 100W unless driven into distortion. Steady state signals such as pure sine waves in excess of 10V rms should not be fed to the loudspeaker.

When the AC power to the loudspeaker is switched off or disconnected, the signal input protection circuit operates to prevent excessive signals being fed to the loudspeaker elements. Even so, care should be taken to ensure that the loudspeakers are not driven for long periods (minutes) with no AC power applied.

Caution: The QUAD logo on the front grill is set to flash if the protection circuit detects abnormally high voltage on the ESL element. If the logo light flashes please switch off for 15 minutes then play again at a lower volume if you were previously listening at loud volume levels. If the logo flashes at normal listening levels and reoccurs after the 15 minutes waiting time then please contact your local Quad Distributor for further advice.

Final Adjustments

After you have finalised the position of the loudspeakers you should level the speaker by adjusting the feet.

Tensioning the Speaker

This is the final adjustment. Tighten the tensioner clockwise. This pulls the tensioning rod tight and makes assembly rigid. As this significantly improves performance at high power levels, do not omit this stage. The tensioner should be periodically checked to ensure the speaker is fully rigid as temperature and humidity variations may cause the tension to slacken slightly.

After all the adjustments have been completed, gently drop the connection panel cover into place.



Mounting Alternatives

After finalising the position of the loudspeakers, for added safety and to improve the coupling with the floor still further, the loudspeakers may be screwed to the floor.

Disconnect each loudspeaker from the mains supply and the amplifier. Mark the position of all four feet with tape or chalk. Place a soft towel or similar item on the floor and lay the loudspeaker carefully on its front. Remove the stabilizing block. Undo the collars on the rear feet half a turn to loosen the bracket and rotate each bracket so that it facing the rear of the loudspeaker. Retighten the collars.

Floor Spikes on Carpet: The pointed foot should only be used with carpets. Adjust the rear feet so that the tapered section of the spike protrudes below the bottom of the bracket. When you screw the bracket into the floor through the carpet, the bracket will rest on the carpet thus avoiding damage to the carpet surface.

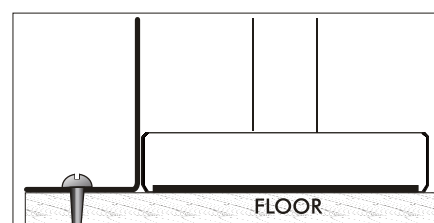
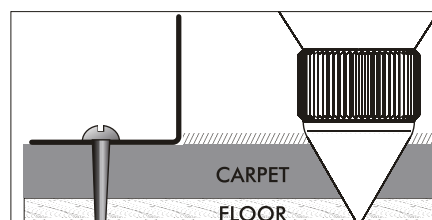

Standard Feet: The bottom of the floor clamp should be marginally above the bottom of the foot. Make sure the feet rest firmly on the floor and that the bracket is not supporting the weight of the loudspeaker.

Stand the speaker upright. Carefully manoeuvre the loudspeaker so that the feet are standing on their marked location. Now screw the clamps to the floor using suitable screws and fixings.

Check that both front feet support the speaker. Reconnect both loudspeakers to the amplifier and the mains supply.

Horizontal Directivity

These are actual measurements taken from our reference samples. The directivity pattern is exceptionally well maintained from very low frequencies to well beyond audibility. This consistent pattern ensures smooth spatial response with no peaks and troughs. In addition, the virtually massless diaphragms of the ESL ensure near-instantaneous starting and stopping with an almost total absence of hysteresis, providing lightning fast transients and phenomenally accurate bass response.

► Quad ESL-2812

Horizontal Directivity

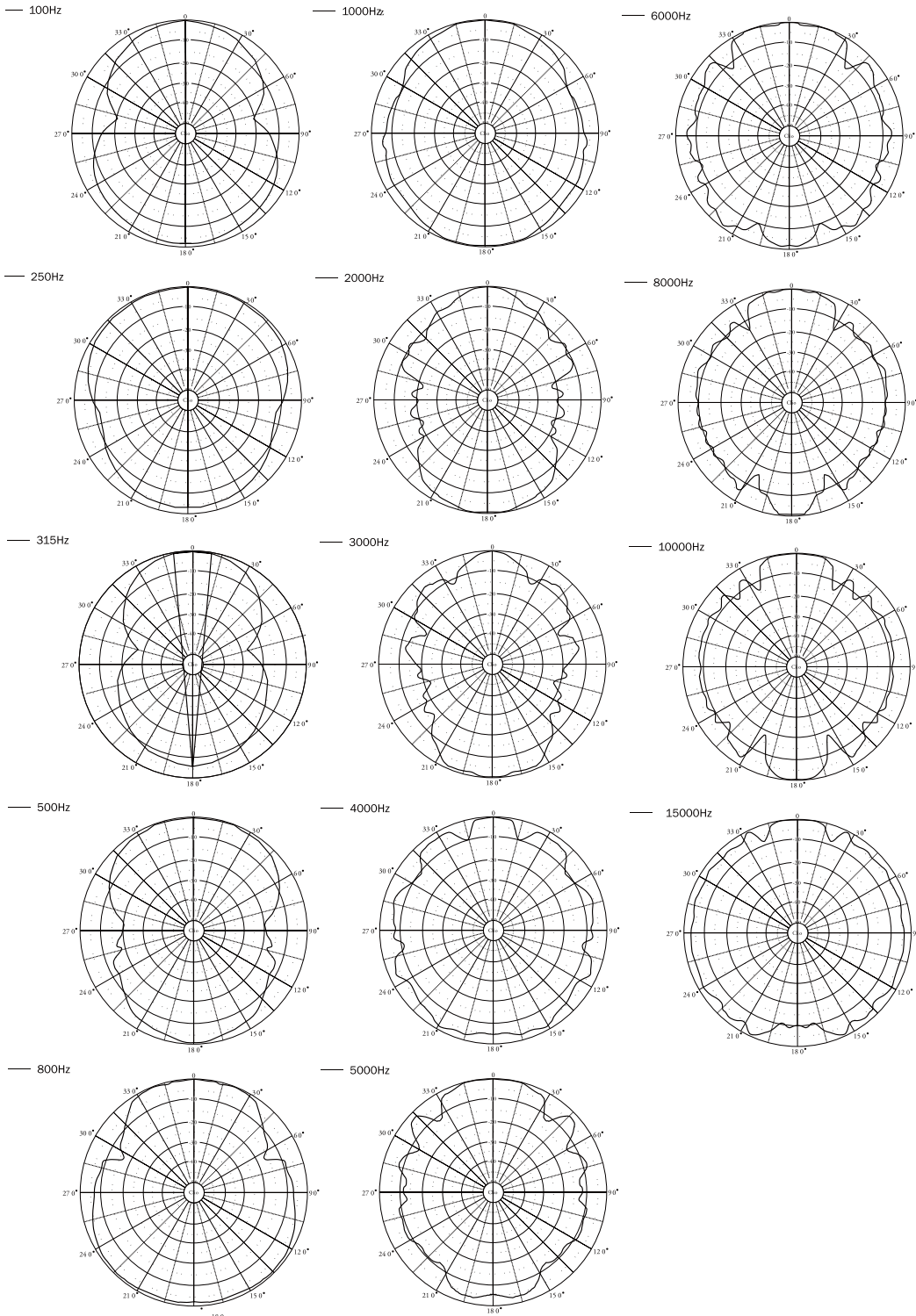

Quad ESL-2912

Horizontal Directivity

100Hz

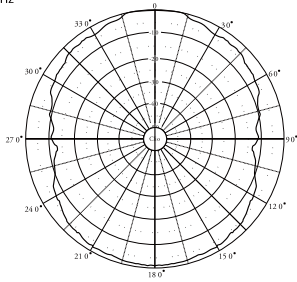

1000Hz

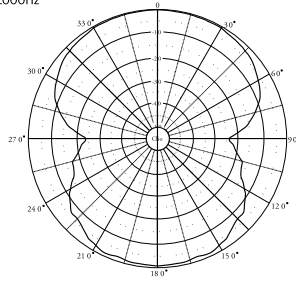

6000Hz

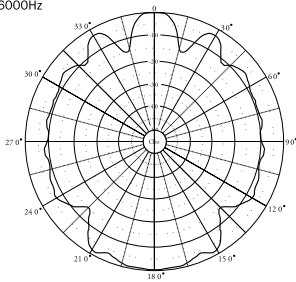

250Hz

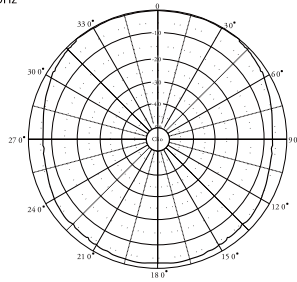

2000Hz

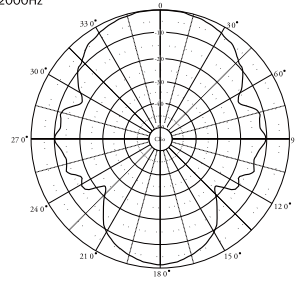

8000Hz

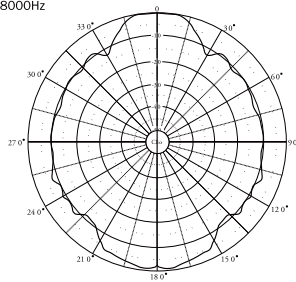

315Hz

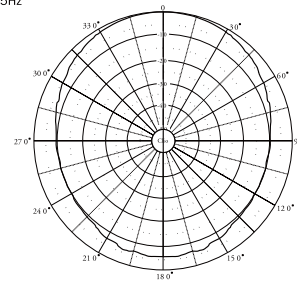

3000Hz

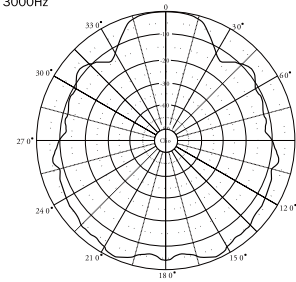

10000Hz

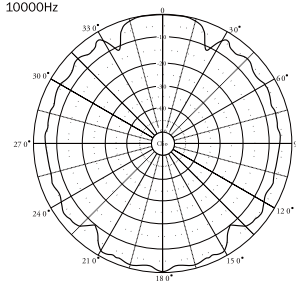

500Hz

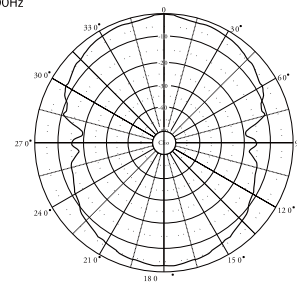

4000Hz

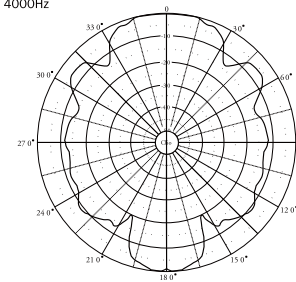

15000Hz

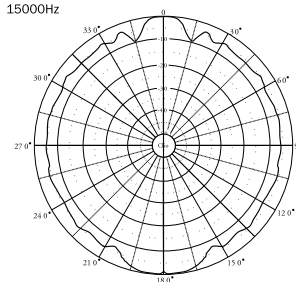

800Hz

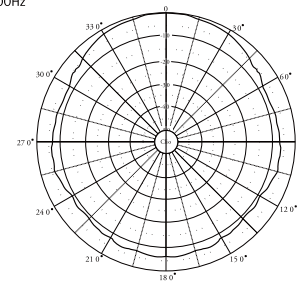

5000Hz

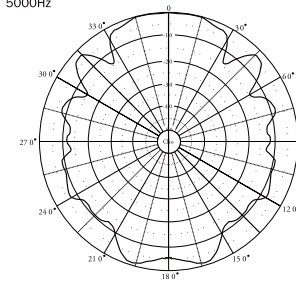

Care and Cleaning

The surfaces of the speaker should be wiped occasionally with a barely damp soft cloth. The grille cloth may be cleaned with a soft brush or a hand held vacuum cleaner. The loudspeakers are protected against the ingress of dust etc. Periodic servicing at two year intervals is recommended to keep your speakers in pristine condition. Great care has gone into the selection of materials to ensure long term stability under a wide range of temperatures and humidity. In countries where the relative humidity regularly exceeds 90% it is recommended that the listening room be air conditioned for optimum performance.

Caution: SWITCH THE LOUDSPEAKERS OFF AND DISCONNECT THEM FROM THE MAINS BEFORE CLEANING.

Servicing

If your Quad equipment requires servicing you should return it to the dealer from whom the equipment was purchased. If you are abroad and there is no suitable dealer in your area, please contact the distributor for the country in which it was purchased or Quad Electroacoustics Ltd. Equipment returned for service should use the original packing. You should enclose a brief note with your name and address and the reason for returning the equipment

Warranty

Your Quad equipment is guaranteed against any defect in material and workmanship for one year from the date of purchase (proof of purchase required). We ask you to complete and return the enclosed Warranty Registration Form (UK). This will also enable us to keep you informed of future Quad products. Within the guarantee period, Quad will undertake replacement of defective parts free of charge provided that the failure was not caused by misuse, accident or negligence. Your statutory rights within the territory in which you purchased the equipment are not affected by this guarantee. Quad carries out a regular review of its products and reserves the right to adjust the specifications and performance from time to time.

There are no user replaceable or serviceable parts inside this equipment. Unauthorised attempts to service or modify this product will invalidate the warranty.

Service Centre Address

IAG Service Dept. Unit 4 St Margaret's Way, Stukeley Meadows Industrial Estate, Huntingdon, Cambs, PE29 6EB, England
Tel: +44 (0)1480 452561 Fax: +44 (0)1480 413403

Q is for Quality

Quad's attention to detail and our standards of quality management are a byword in the hi-fi industry.

The finest C-Core transformers are used in the audio path providing excellent linearity, wide bandwidth and very low phase shift.



Inspecting a panel

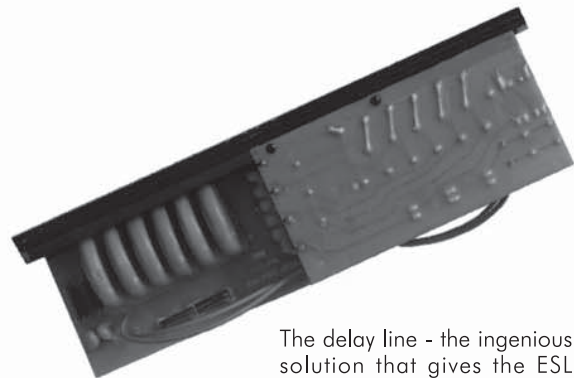

The delay line - the ingenious solution that gives the ESL its legendary point-source capability.

Section of a panel – note the concentric rings.

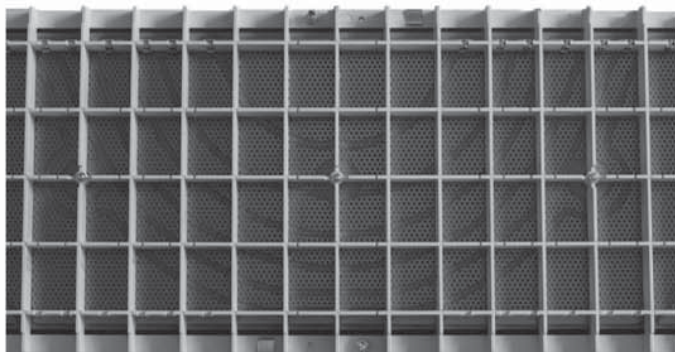

About Your ESL Loudspeaker

Your ESL loudspeaker consists of a vertical multiple element or membrane line array mounted on top of an electronic matching circuit contained within the base structure.

In order to achieve the efficiency needed for full range audio operation a large moving diaphragm is required. This is achieved using several individual elements connected within a rigid frame. The smaller ESL 2812 features 4 elements, 2 bass elements and 2 mid and high frequency elements, whilst the ESL 2912 features 6 elements by the addition of two further bass elements.

The membrane (diaphragm) in each element is a highly charged ultra light, immensely strong plastic film, pre-stretched and fixed to an open frame. To achieve constant-charge conditions this membrane is coated with a specially formulated high-resistivity coating. This membrane is one tenth of the thickness of a human hair and virtually massless compared to other types of loudspeaker. Again, unlike a conventional loudspeaker, the membrane, when energised, is driven simultaneously over its entire surface. This combination results in an extremely fast transient response - the diaphragm responds to alternating motion without introducing any time lag - completely unlike the sluggish, high-mass conventional loudspeaker.

The ESL is a dipole – the sound radiates equally from both sides of the diaphragm.

The centre two panels in each loudspeaker incorporate divisions in the diaphragm. These can be seen as concentric rings on the outer grid plates surrounding the diaphragm. Each ring is subjected to a minuscule time delay and attenuated by its own individual circuit, the sound spreading gradually from the centre outwards through each successive ring. This carefully structured delay line creates a near-perfect spherical wave front originating from an apparent point 400mm behind the loudspeaker. In the vertical plane the elements are line arrayed, the mid and high frequency elements being centrally sited to preserve the spherical shape.

In order to eliminate even the slightest cancellation effect caused by diaphragm motion interacting with the speaker frame, the base is weighted at the rear with a steel mass spaced away from the cabinet base. An adjustable strut further increases rigidity and improves cabinet coupling. The result is a structure of immense stability and rigidity.

The ultimate design goal of any high-fidelity loudspeaker is faithfully to preserve the illusion of a naturally occurring sonic event. That this is fully realised by the Quad ESL in practice can be seen from the loudspeakers' polar plots reproduced on Pages 8 and 9. These loudspeakers give a truly three dimensional sound stage like no other.

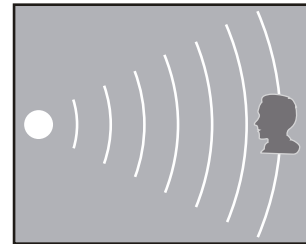

1: A perfect point source produces a spherical wave pattern.

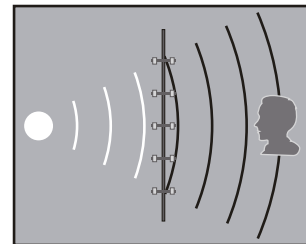

2: Air particle movement at a plane some distance from the source.

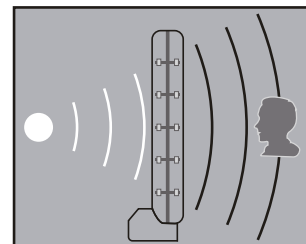

3: An identical movement in the ESL membrane produces an identical wave front.

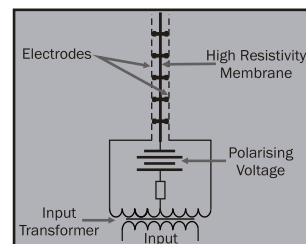

4: The membrane carries a constant charge. The charge on the electrodes fluctuates according to the music signal.

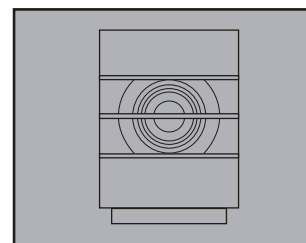

5: The music signal is fed first to the centre section, then to each ring in turn via delay coils

Specifications

Model	ESL 2812	ESL 2912
Format	Floor standing dipole with 3° fixed tilt	Floor standing dipole with 3° fixed tilt
Type	Multiple electrostatic drive membranes	Multiple electrostatic drive membranes
Point Source Time Delay	Progressive concentric rings	Progressive concentric rings
Chassis Structure	Heavy duty composite aluminium / steel	Heavy duty composite aluminium / steel
Panel Elements	4	6
Maximum Output	2 N/m ² at 2m on axis	2 N/m ² at 2m on axis
Sensitivity	1.5 mbar per volt referred to 1m (86dB/2.83V rms equivalent)	1.5 mbar per volt referred to 1m (86dB/2.83V rms equivalent)
Nominal Impedance	8 Ohms	8 Ohms
Impedance Variation	4 - 15 Ohms	4 - 20 Ohms
Maximum Input	Continuous input voltage (rms): 10V Programme Peak for undistorted output: 40V Permitted peak input: 55V	Continuous input voltage (rms): 10V Programme Peak for undistorted output: 40V Permitted peak input: 55V
Frequency Response	37Hz - 21kHz (-6dB) 33Hz - 23kHz (useable)	32Hz - 21kHz (-6dB) 28Hz - 23kHz (useable)
Directivity Index	See Polar Diagrams	See Polar Diagrams
Distortion (100dB @ 1m)	Above 1000Hz <0.15% Above 100Hz <0.5% Above 50Hz <1.0%	Above 1000Hz <0.15% Above 100Hz <0.5% Above 50Hz <1.0%
AC Input	220 - 240V, 110 - 120V, 100V	220 - 240V, 110 - 120V, 100V
Power Fuse	63mA anti-surge, 200 - 240V 100mA anti-surge, 100 - 120V	63mA anti-surge, 200 - 240V 100mA anti-surge, 100 - 120V
Power Consumption	6W	6W
Dimensions (H x W x D)	1070 x 690 x 380 (mm)	1470 x 690 x 380 (mm)
Net Weight	35kg	44kg

* The right is reserved to alter performance, specifications and appearance as required.

Physical Measurement

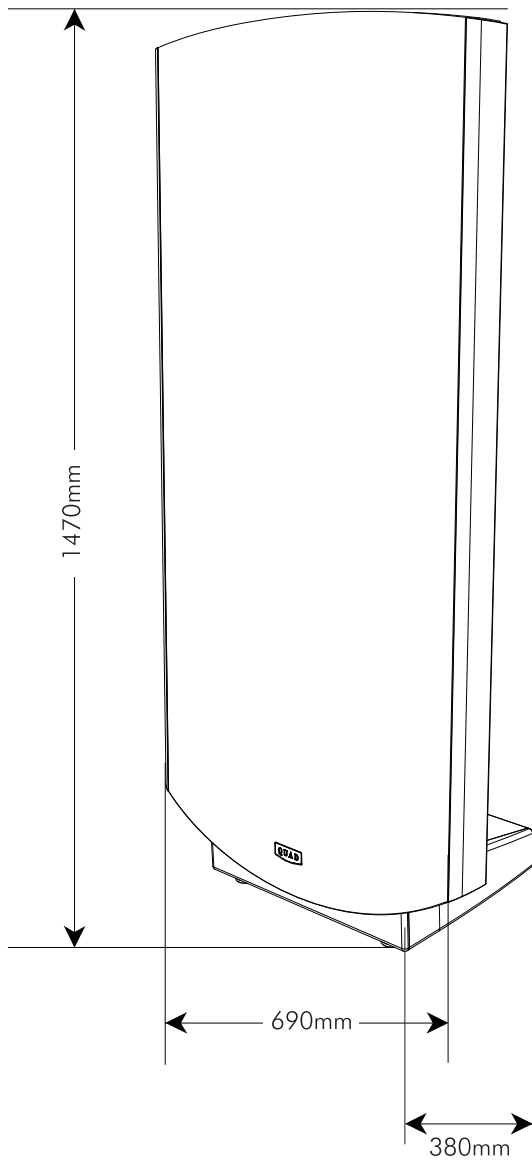

ESL 2912

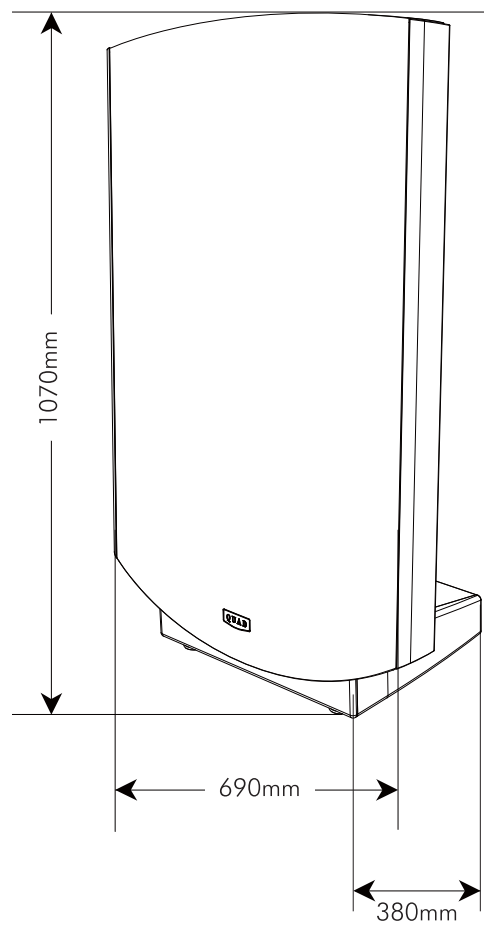

ESL 2812

* The dimensions stated include spikes.

The Closest Approach

Quad - The Closest Approach,
edited by Ken Kessler and Gordon Hill

A 240 page hard-back, authoritative history with commentaries and contributions from every corner of the hi-fi industry. Technical chapters from Tim De Paravicini and Gordon Hill and interviews with Peter Walker, Ross Walker, Stan Curtis and Mike Albinson. Along with a series of stunning new photographs, fascinating historic documents and reproductions of AES and other technical papers, this is the definitive guide to the history and achievements of Quad.

Available through all good book retailers or any of our Dealers, from the Hi-Fi News Accessory Club, the Hi-Fi Collective, or the Quad Service Department.

ISBN number 0-9545742-0-6

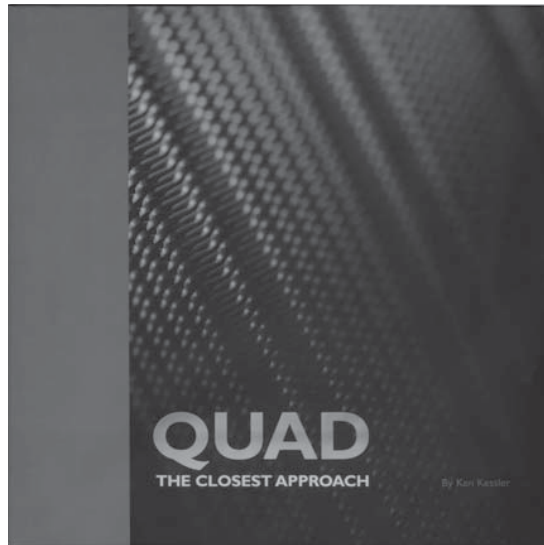

The Birth of a Legend.

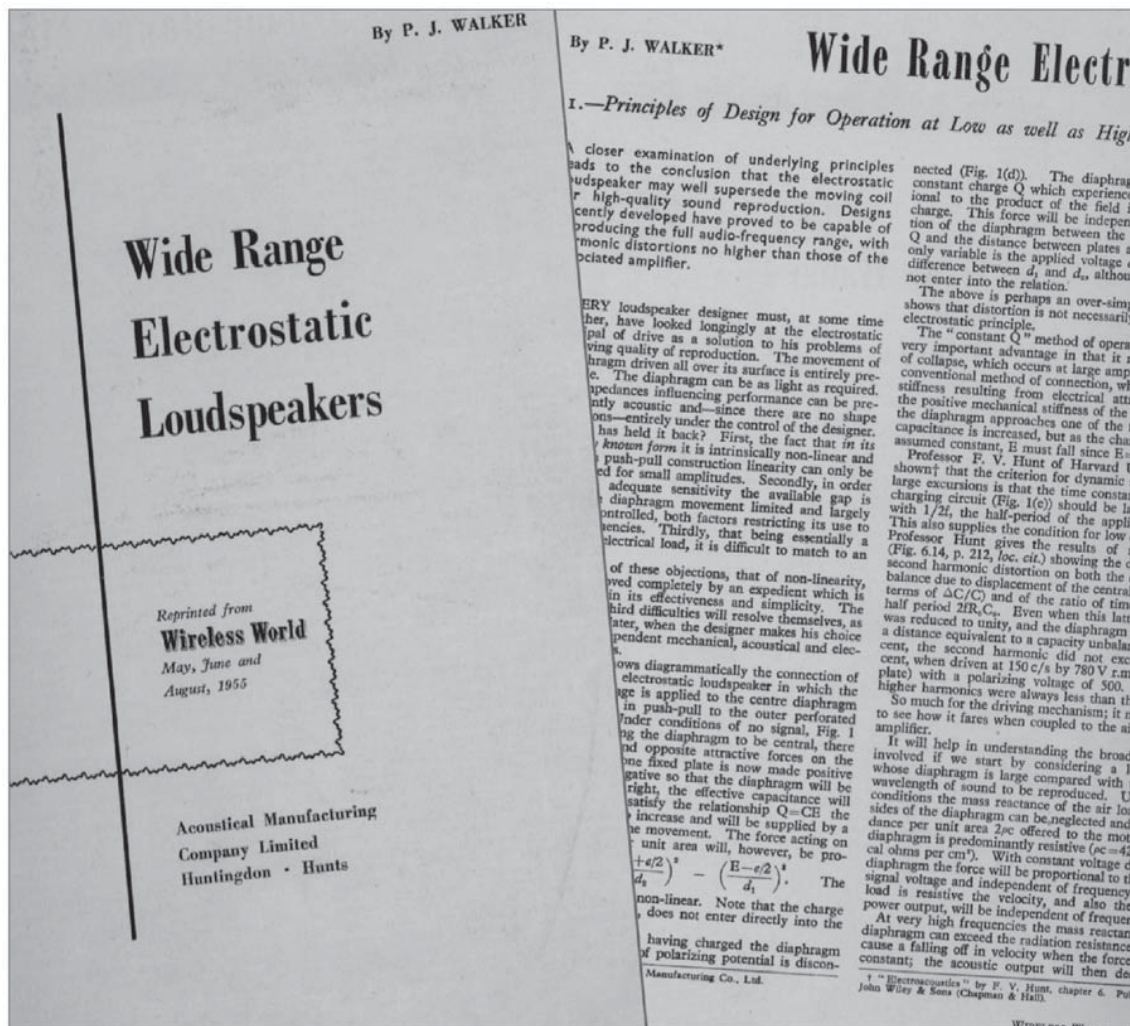



QUAD

IAG House, Sovereign Court, Ermine Business Park, Huntingdon, Cambs, PE29 6XU, UK
Tel: +44(0)1480 447700 Fax: +44(0)1480 431767 www.quad-hifi.co.uk
IAG reserves the right to alter the design and specifications without notice. All rights reserved © IAG Group Ltd.
Quad is a member of the International Audio Group. CODE: QH12-MNL001a